

SMD LED LAMP
BL-LS0805XX
■ Features:

- 2.0mmx1.25mm SMD, 0.8mm THICKNESS
- Mono-color type
- Compatible with automatic placement equipment
- WIDE VIEWING ANGLE.
- IDEAL FOR BACKLIGHT AND INDICATOR.
- PACKAGE: 4KPCS/REEL
- RoHs Compliance

■ Electrical-optical characteristics: (Ta=25°C) (Test Condition: IF=20mA)

Part Number	Chip			Lens Type	Forward Voltage(VF) Unit:V		Luminous Intensity (lv) Unit:mcd		Viewing Angle 2θ1/2 (deg)
	Emitted Color	Material	λ _P (nm)		Typ	Max	Min.	Typ.	
					BL-LS0805HC	Red	GaP	700	
BL-LS0805SRC	Super Red	AlGaAs	660	1.85	2.30	5	13		
BL-LS0805LRC	Super Red	AlGaAs	660	1.85	2.30	10	28		
BL-LS0805EC	Orange	GaAsP	640	2.10	2.70	1	6		
BL-LS0805YC	Yellow	GaAsP	583	2.15	2.70	1	6		
BL-LS0805GC	Green	GaP	568	2.30	2.70	6	15		

■ Absolute maximum ratings (Ta=25°C)

Parameter	H	SR	LR	UR	E	Y	G	Unit
Forward Current I _F	30	30	30	30	30	30	30	mA
Power Dissipation P _d	65	78	78	78	65	65	65	mW
Reverse Voltage V _R	5	5	5	5	5	5	5	V
Peak Forward Current I _{PF} (Duty 1/10 @1KHZ)	100	100	100	100	100	100	100	mA
Operation Temperature T _{OPR}	-30 to +80							°C
Storage Temperature T _{STG}	-40 to +85							°C
Lead Soldering Temperature T _{SOL}	Max.260±5°C for 3 sec Max. (1.6mm from the base of the epoxy bulb)							°C

SMD LED LAMP
BL-LS0805XX
■ Electrical-optical characteristics: (Ta=25°C) (Test Condition: IF=20mA)

Part Number	Chip			Lens Type	Forward Voltage(VF) Unit:V		Luminous Intensity (Iv) Unit:mcd		Viewing Angle 2θ1/2 (deg)
	Emitted Color	Material	λ _P (nm)		Typ	Max	Min.	Typ.	
					BL-LS0805UDR	Ultra Red	AlGaAs	655	
BL-LS0805UHR	Ultra Red	AlGaAs	645	2.10	2.60	30	80		
BL-LS0805UEC	Ultra Orange	AlGaAs	630	2.10	2.50	30	70		
BL-LS0805UHD	Ultra Orange	AlGaAs	618	2.10	2.60	50	110		
BL-LS0805UYO	Ultra Amber	AlGaInP	610	2.10	2.60	30	70		
BL-LS0805UYC	Ultra Yellow	AlGaInP	593	2.10	2.60	25	75		
BL-LS0805UGC	Ultra Green	AlGaInP	575	2.20	2.70	10	45		
BL-LS0805PGC	Ultra Pure Green	InGaN	525	3.50	4.20	50	100		
BL-LS0805BGC	Ultra Bluish Green	InGaN	505	3.50	4.20	50	110		
BL-LS0805DNB	Blue	InGaN	470	3.50	4.20	10	38		
BL-LS0805UBC	Ultra Blue	InGaN	470	3.50	4.20	10	30		
BL-LS0805UWC	Ultra White	InGaN	/	3.50	4.20	40	200		

■ Absolute maximum ratings (Ta=25°C)

Parameter	UDR	UHR	UE	UHD	UYO	UY	UG	PG	BG	DNB	UB	UW	Unit
Forward Current I _F	30	30	30	30	30	30	30	30	30	30	30	30	mA
Power Dissipation P _d	78	78	78	78	78	78	78	78	78	78	78	78	mW
Reverse Voltage V _R	5	5	5	5	5	5	5	5	5	5	5	5	V
Peak Forward Current I _{PF} (Duty 1/10 @1KHZ)	100	100	100	100	100	100	100	100	100	100	100	100	mA
Operation Temperature T _{OPR}	-30 to +80												°C
Storage Temperature T _{STG}	-40 to +85												°C
Lead Soldering Temperature T _{SOL}	Max.260±5°C for 3 sec Max. (1.6mm from the base of the epoxy bulb)												°C

SMD LED LAMP

BL-LS0805XX

■ **Package configuration & Internal circuit diagram**

BL-LS0805 Series

Package Outline Drawing

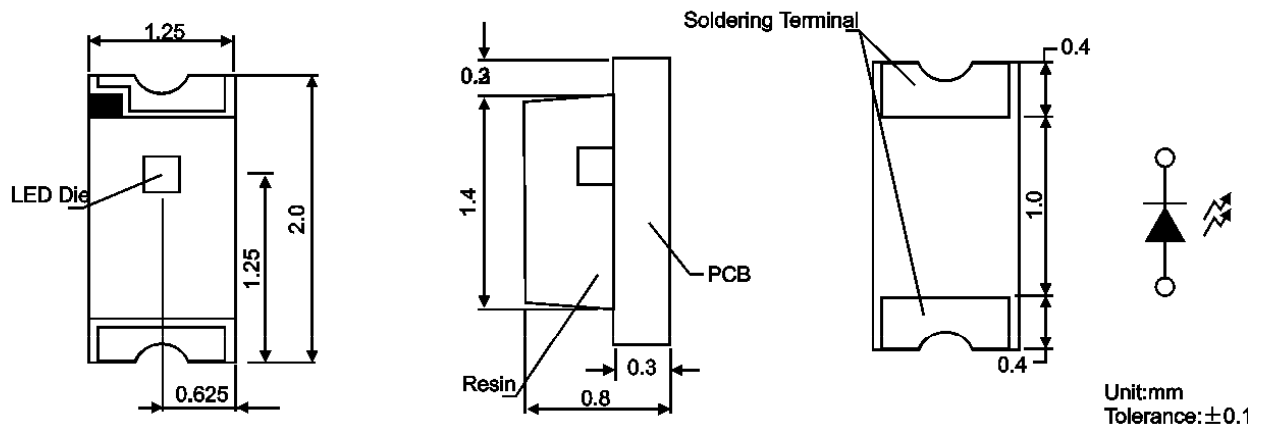

Recommended Soldering Pad Dimensions

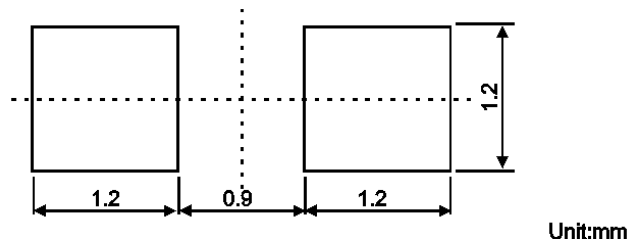

Notes:

1. All dimensions are in millimeters (inches)
2. Tolerance is $\pm 0.25(0.01)$ unless otherwise noted.
3. Specifications are subject to change without notice.

SMD LED LAMP

BL-LS0805XX

■ **Tape Specifications**

Unit: mm

Tolerance: ± 0.1

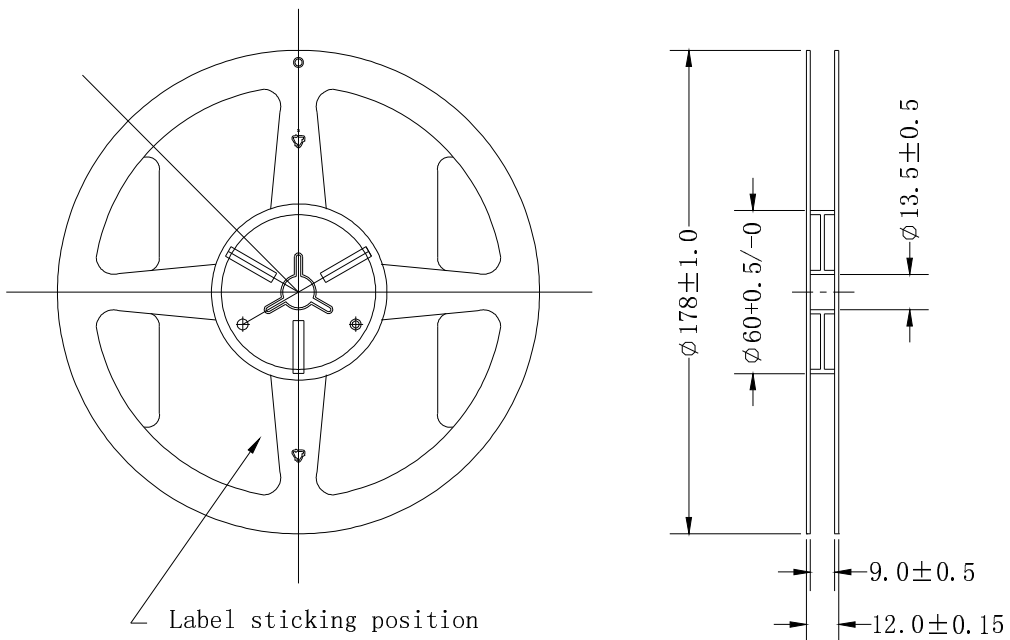
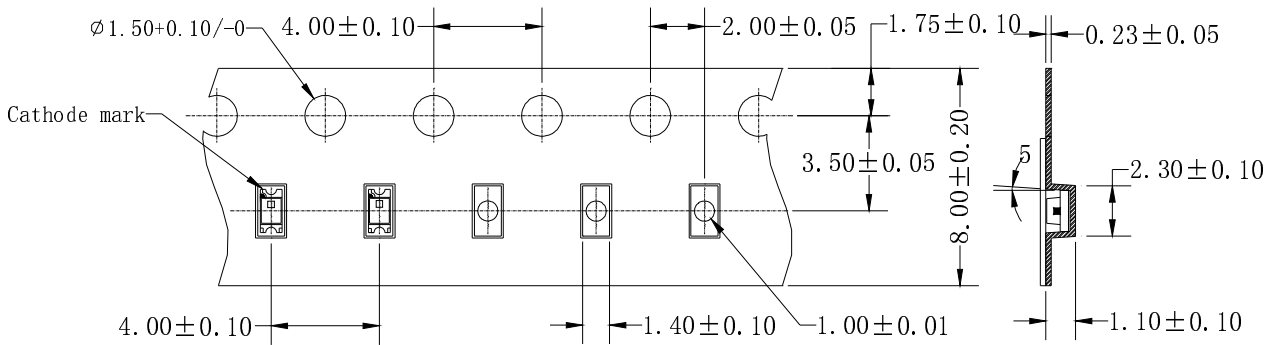

SMD LED LAMP

BL-LS0805XX

Typical electrical-optical characteristics curves:

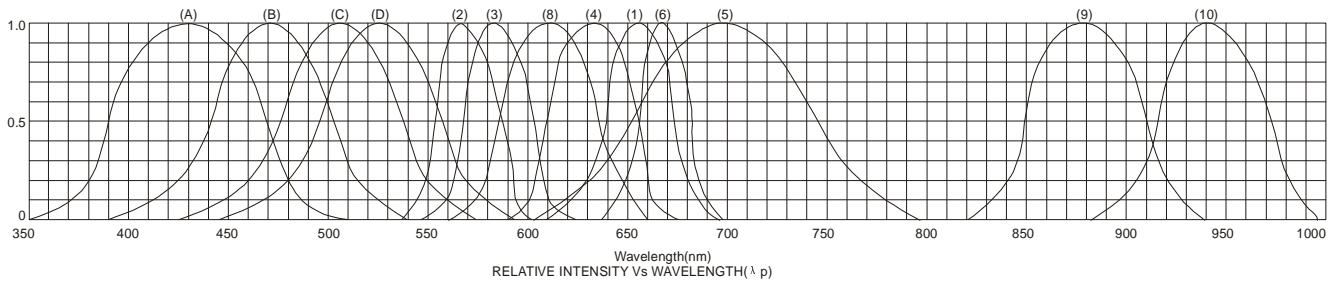

- | | |
|---|--------------------------------------|
| (1) - GaAsP/GaAs 655nm/Red | (9) - GaAlAs 880nm |
| (2) - GaP 570nm/Yellow Green | (10) - GaAs/GaAs & GaAlAs/GaAs 940nm |
| (3) - GaAsP/GaP 585nm/Yellow | (A) - GaN/SiC 430nm/Blue |
| (4) - GaAsP/GaP 635nm/Orange & Hi-Eff Red | (B) - InGaN/SiC 470nm/Blue |
| (5) - GaP 700nm/Bright Red | (C) - InGaN/SiC 505nm/Ultra Green |
| (6) - GaAlAs/GaAs 660nm/Super Red | (D) - InGaN/SiC 525nm/Ultra Green |
| (8) - GaAsP/GaP 610nm/Super Red | |

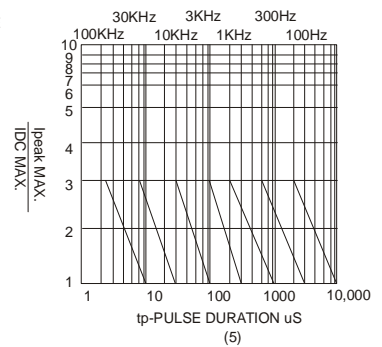
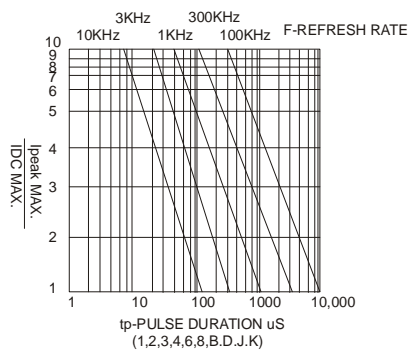
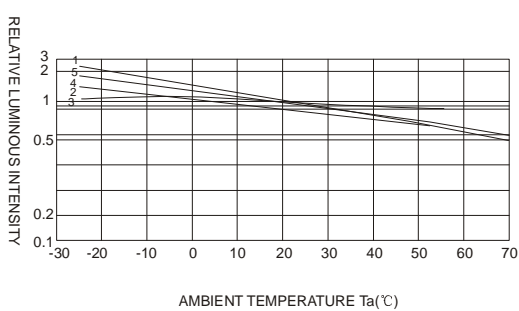
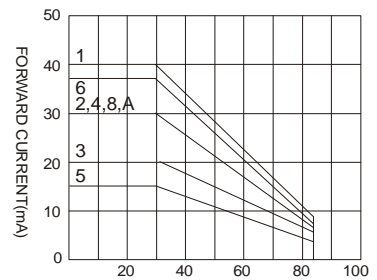
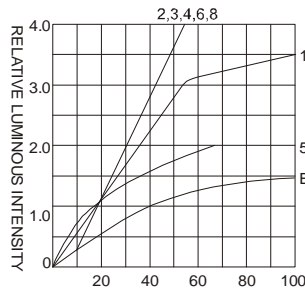
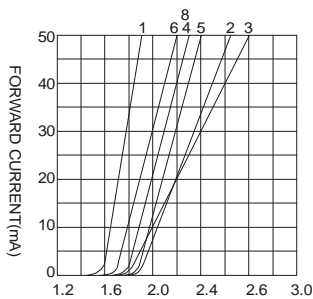

NOTE:25°C free air temperature unless otherwise specified